

# Steel Pressings Forgings & Hammerings: Group 1 - Pole Caps

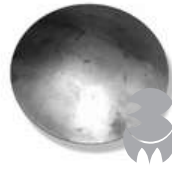

## Pole Cap

11001 - 30mm dia.  
11002 - 40mm dia.  
11003 - 50mm dia.  
11004 - 63mm dia.  
11005 - 63 hole 7mm  
11006 - 70mm dia.  
11007 - 76mm dia.  
11008 - 85mm dia.



## Pole Cap

11009 - 90mm dia.  
11010 - 100mm dia.  
11011 - 110mm dia.  
11016 - 115mm dia.  
11012 - 125mm dia.  
11013 - 140mm dia.  
11014 - 140 deep  
11017 - 150 deep  
11015 - 160mm dia.



## Pole Cap

11050 - 25mm sq  
11051 - 38mm sq  
11052 - 50mm sq  
11053 - 63mm sq  
11054 - 76mm sq  
11055 - 90mm sq  
11056 - 110mm sq  
11057 - 100mm sq  
11058 - 125mm sq



## Ringed Candle Base

11062 - 75mm dia.  
11063 - 85mm dia.  
11064 - 100mm dia.  
11065 - 110mm dia.  
11066 - 125mm dia.  
11067 - 140mm dia.  
11068 - 150mm dia.  
11069 - 160mm dia.



## Black Lipped Pole Cap

11025 - fit 38mm dia.  
11029 - fit 51mm dia.  
11031 - fit 60mm dia.  
11033 - fit 76mm dia.  
11035 - fit 102mm dia.



## Pyramid Pole Cap

11071 - fit 38sq 50 x 50mm  
11072 - fit 50sq 76 x 76mm  
11073 - fit 76sq 100 x 100mm  
11074 - fit 100sq 116 x 116mm  
11077 - fit 150sq 190 x 190mm  
11075 - fit 200sq 242 x 242mm



## Flat Disc

11086 - 25mm dia.  
11081 - 30mm dia.  
11094 - 40mm dia.  
11082 - 50mm dia.  
11083 - 60mm dia.  
11084 - 65mm dia.  
11085 - 75mm dia.  
11087 - 85mm dia.



## Flat Disc

11088 - 90mm dia.  
11089 - 100mm dia.  
11090 - 115mm dia.  
11091 - 125mm dia.  
11092 - 140mm dia.  
11078 - 150mm dia.  
11093 - 160mm dia.  
11079 - 200mm dia.

# Steel Pressings Forgings & Hammerings:

## Group 1 - Pressings & Centre Spinnings

### Flat Spun Spot Base



11201 - Small 175mm dia.  
11202 - Med. 240mm dia.  
11203 - Large 350mm dia.

### Square Base Plate

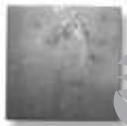

11305 - 150/3mm  
11307 - 200/5mm  
11309 - 300/5mm

### Base Plate

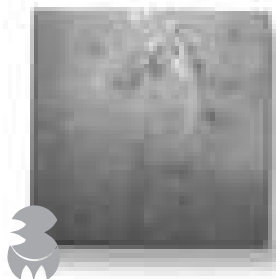

11140 - 50x50x3mm  
11141 - 100x100x2mm  
11142 - 100x100x3mm  
11144 - 150x150x2mm  
11145 - 150x150x3mm  
11146 - 150x150x5mm  
11147 - 200x200x2mm  
11148 - 200x200x3mm  
11149 - 200x200x5mm  
11150 - 300x300x2mm  
11151 - 300x300x3mm  
11152 - 300x300x5mm

11219



Parrot Cage Top  
154 x 50mm

### Domed Candle Base



11212 - 220mm dia,  
11213 - 200mm dia.  
11214 - 350mm dia.  
11215 - 250mm dia.  
11216 - 500mm dia.  
11217 - 300mm dia.

### Spun Dish



11204 - Small 175mm dia.  
11205 - Medium 240mm dia.  
11206 - Large 350mm dia.

11221

Lamp Base  
155 dia. x 50mm deep



11223

Lotus Base  
215 dia. x 38mm deep

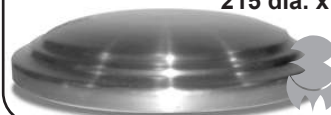

11225

Spun Lamp Base  
615 dia. x 155mm deep



11222

Lamp Base  
206 dia. x 70mm deep



# Steel Pressings Forgings & Hammerings: Group 1 - Silhouettes

**11080**



No 9/3 Viking  
112 x 64mm

**Diamond**



11095 - No 1/3 Silhouette  
60 x 25mm  
11096 - No 2/3 Silhouette  
78 x 35mm  
11097 - No 3/3 Silhouette  
98 x 45mm

**11098**



No 5/3  
Spade/Club  
75 x 53mm

**11099**

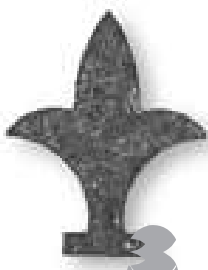

No 7/3  
Fleur de Lis  
92 x 71mm

**11719**



Baboon & Baby  
120x161

**11701**



Lion  
110x203

**11702**



Rhino  
100x220

**11703**



Elephant  
134x199

**11704**

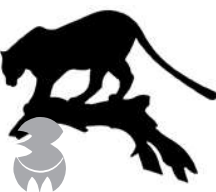

Leopard  
139x219

**11711**



Giraffe  
250x133

**11712**



Giraffe & Tree  
222x195

**11713**

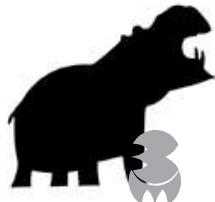

Hippo  
153x166

**11714**



Kudu  
197x157

**11715**



Sable  
173x170

**11716**



Wildebeest &  
Tree

**Impala Frieze**



11717 - 440 x 155mm

# Steel Pressings Forgings & Hammerings:

## Group 1 - Silhouettes & Wall Spikes

11721

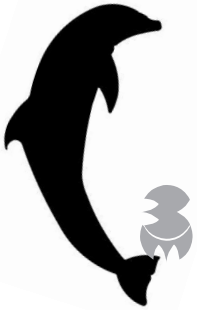

Curved Dolphin  
207 x 75mm

11720



Straight Dolphin  
212 x 75mm

11723



Meerkat  
200 x 140mm

11725

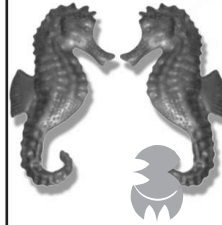

Seahorse L/R  
132 x 70mm

11726



Dolphin L/R  
140 x 86mm

11741



Fleur de Lis 21/2D  
93 x 73mm

11742



Viking 21/2D  
111 x 65mm

11743



Anglo 21/2D  
108 x 83 mm

11744



Sunflower w leaves  
107 x 150mm

11852



MK2 Plated Wall  
Spike, 31mm x 1.5m  
Tooth 51mm

11853



MK3 Plated  
Wall Spike,  
46mm x 1,5m  
Tooth 60mm

11854



MK4 Plated  
Wall Spike,  
31mm x 1,5m  
Teeth 51mm 4 way

11855



MK5 Plated  
Wall Spike,  
45mm x 1,5m  
Teeth 60mm 4 way

11859



Sabre Tooth  
Wall Spike  
45mm x1.5m  
Teeth 110 + 25mm

11860



Tiger  
Wall Spike  
30mm x1.5m  
Teeth 75 + 15mm

# Steel Pressings Forgings & Hammerings: Group 1 - Hinges, Lugs

11113



Short Parliament  
Hinge 80 x 65mm

11111



Long Parliament  
Hinge 168 x 58mm

11112



Butterfly  
Hinge 80 x 65mm

Double Bracket Hinge



11116 - Short  
11117 - Long

Truck Dropside Hinge



11114 - Long  
11115 - Henred

Dummy Frame Hinge



13512 - 430x110mm  
13513 - 330x120mm

11826



Fish Tailed Lug  
100x30x5mm

Dummy Fleur Hinge

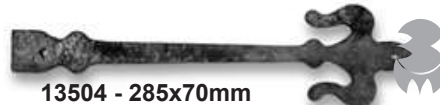

13504 - 285x70mm  
13505 - 390x100mm

Dummy Lance Hinge



13502 - 315x115mm  
13503 - 450x170mm

Hole Lug



11821 - 50x40x5 10.5mm  
11822 - 50x40x5 12.5mm  
11823 - 50x40x5 16.5mm  
11824 - 50x30x5 10.5mm  
11825 - 50x30x5 12.5mm

Bullet Hinge

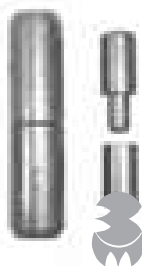

11102 - BH120x30mm  
11103 - BH100x25mm  
11104 - BH100x20mm  
11105 - BH100x16mm  
11106 - BH100x12mm  
11107 - BH70x20mm  
11108 - BH70x16mm  
11109 - BH70x12mm  
11110 - BH50x10 mm

11100



Ball Bearing Hinge  
140 x 40mm

11101



Ball Bearing Hinge  
120 x 30

# Steel Pressings Forgings & Hammerings: Group 1 - Locks, Keys

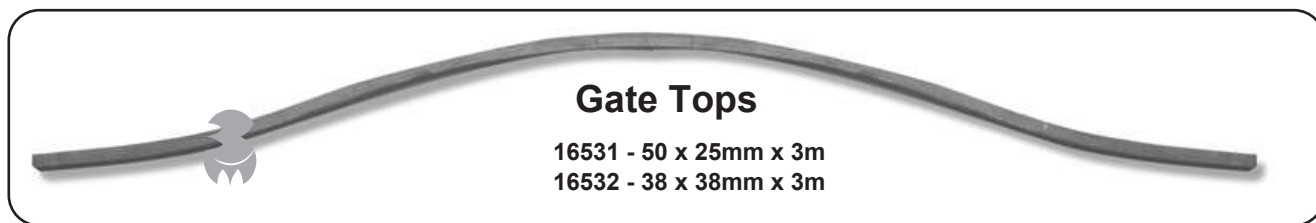
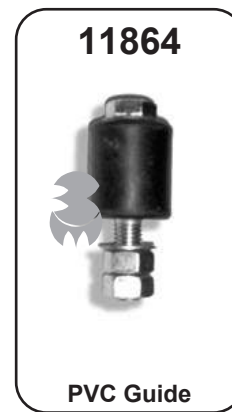
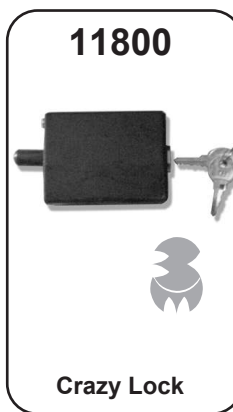
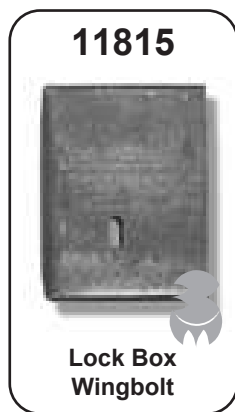
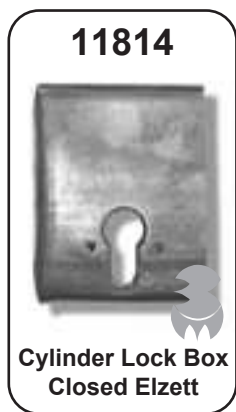
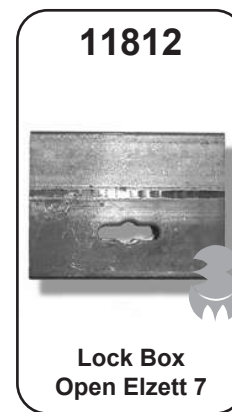
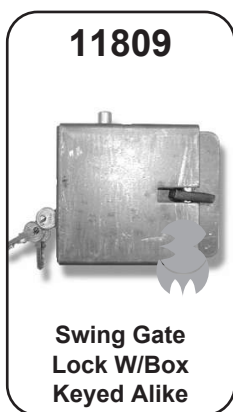
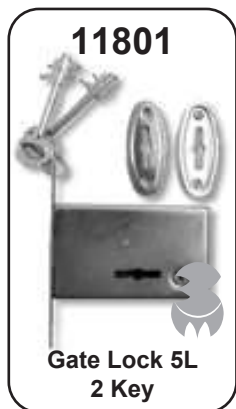

# Steel Pressings Forgings & Hammerings:

## Group 1 - Pressings & Forgings

**13001**

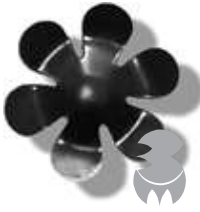

Cosmos  
70mm dia.

**13002**



Daisy  
50mm dia.

**13003**



Maple  
56x50mm

**13015**



Pin Oak Leaf  
106x54mm

**13006**



Tulip Tree Leaf  
91x65mm

**13008**



Artichoke Leaf  
80x40mm

**13009**

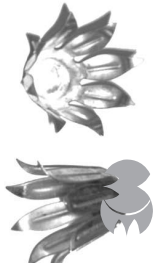

Protea 8 Petal  
51x67mm dia.

**13010**

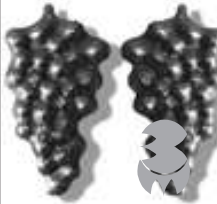

Grapes L/R  
110x62mm

**Grape Leaf**

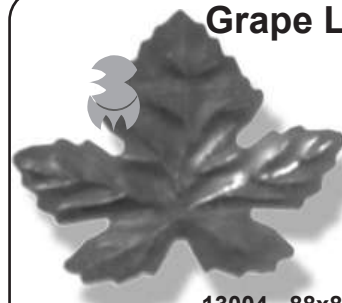

13004 - 88x85mm  
13019 - 68x73mm



**Magnolia Leaf**

13016 - 150x43mm  
13257 - 211x53mm  
13437 - 205x55mm

**Rose Leaf Veined**



13012M - 34 x 45mm  
13012L - 63 x 44mm  
13012S - 38 x 27mm

**13021**



Rose Petal  
Candle Holder  
60 x 30mm



**Clip on Rose Leaf**

13026 - 28x55mm  
13027 - 37x70mm

**13022**



Grape Leaf Lrg  
95x110mm

**13025**



Cosmos EMB RASD  
CNTR 70mm dia.

**13028**



Petunia 5 Petal  
85mm dia.

**Pressed Ivy**



13037 - 113x76 PL37  
13038 - 42x54 PL38

**Acorn**



13226 - 16x30mm  
1322M - 20x45mm  
13225 - 25x45mm  
13225X - 30x55mm

# Steel Pressings Forgings & Hammerings:

## Group 1 - Pressings & Forgings

13036A



Red Oak Leaf  
1.0 x 95 x 94mm

13039



Wild Garlic L/R  
60x70mm

13040



Gousblom 12 Petal  
75mm dia.

13042



Daisy Leaf  
71x20x2.5mm

13228



Poinsettia  
135mm dia.

13220



Fern Leaf  
300x25mm

13250



Antirrinum Long  
167x63

13227



Rosebud on Stem

13252



Stamen  
70x10mm dia.

13020G



Red Oak Leaf Giant  
187 x 142 mm

13234



Cymbidium Leaf  
L/R 85x100mm

13246



Giant Fern  
280 x 110mm

Acanthus Leaf



13007 - 120x41mm  
13024 - 222x70mm

13228



Burmese Palm Leaf  
LR 105 x 45mm

13251



Syngonim  
Butterfly Leaf  
109x92mm

13256



Baroque Fern Profile  
310x70x4mm

Anenome

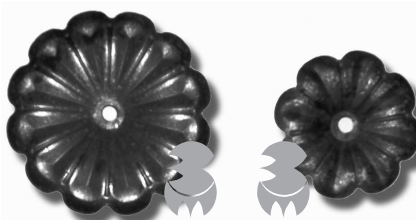

13043 - 93 dia 2 mm  
13043 s - 65 dia 2 mm



# Steel Pressings Forgings & Hammerings: Group 1 - Pressings & Forgings

**Apple Leaf**  
13242 - Small  
13243 - Large



**13260**  
Kalanchoe Leaf  
160x330mm L/R



**13263**  
Baroque Leaf L/R  
~2mm 90x155mm



**13264**  
Baroque Leaf L/R  
~2mm 380x180mm



**Arum Lily**  
13457 - Small  
13458 - Medium  
13459 - Large



**13265**  
Baroque Leaf  
~2mm L/R



**13266**  
Baroque Leaf  
~2mm L/R



**13435**  
Day Lily Leaf L/R  
35x140mm



**Cork Oak Leaf**  
13247 - Flat 155x8mm  
13248 - Crvd 150x60mm



**6 Petal Daisy**  
13253 - 120mm dia.  
13254 - 90mm dia.  
13255 - 65mm dia.



**St Joseph Lilly**  
13460 - 160x35mm  
13460s - 135x30mm



**13439**  
Croton Leaf  
250x140mm



**Bullrush**  
13488 - 14mm dia. x 130  
13489 - 17mm dia. x 130  
13490 - 27mm dia. x 120



**Rose Large**  
13239 L - 70 dia x 55 mm



# Steel Pressings Forgings & Hammerings: Group 1 - Pressings & Forgings

13440



Sunflower  
135mm dia.

13441



Baseplate 6 Point  
2 Way

13424



Base Plate Open  
190mm dia.



Half Palm Tree

13498 - 140x250mm  
13500 - 230x355mm



Full Palm Tree

13499 - 140x250mm  
13501 - 230x355mm

13425



Base Plate Closed  
180mm dia.

13495



Curved Leaf Spear  
180x23mm 12sq

13493



13493 - 125x95  
13493S - 95x70



Candle Base

13018 - Candle Base  
75mm dia.



D/Curved Leaf Spear

13496 - 167 x 23mm, 12sq  
13496D - 130x20mm, 12 sq

13494



Leaf Spear  
190x23mm 12sq

13449



St Joseph Lilly  
75 x 160mm

13419



Moon  
175mm dia.



Candle Base

13011 - 120mm dia.  
13017 - 100mm dia.



Candle Holder

13014 - ID 35mm  
13013 - ID22mm  
13035 - ID 12mm

13430



Star  
150mm dia.

13479



Trout  
270 x 105mm

13518



Weather Cock  
553 x 400mm

13519



Weather Cock  
337 x 285mm

# Steel Pressings Forgings & Hammerings:

## Group 1 - Pressings & Forgings

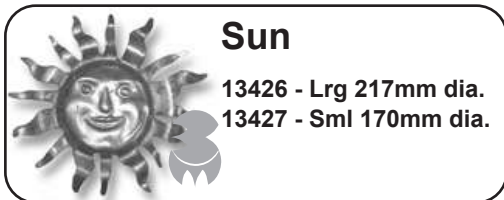

**Sun**

13426 - Lrg 217mm dia.  
13427 - Sml 170mm dia.



**13497**

Forged Lion Head  
82x72mm



**13509**

Angel Fish  
245x180mm



**13517**

Bishops Crook

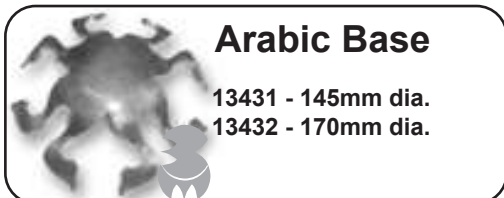

**Arabic Base**

13431 - 145mm dia.  
13432 - 170mm dia.



**13481**

Shepherd's Crook  
185 x 110mm



**Flying Fish**

13420 - 150x245mm  
13522 - 235x370mm  
13480 - 430x770mm

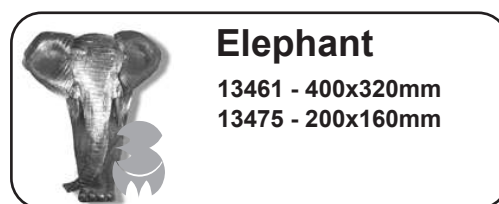

**Elephant**

13461 - 400x320mm  
13475 - 200x160mm

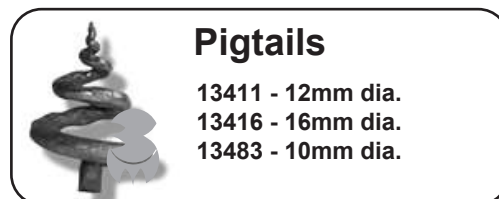

**Pigtails**

13411 - 12mm dia.  
13416 - 16mm dia.  
13483 - 10mm dia.



**Snail Curl**

13409 - Sml 12mm dia.  
13415 - Lrg 12mm dia.  
13423 - 16mm dia.

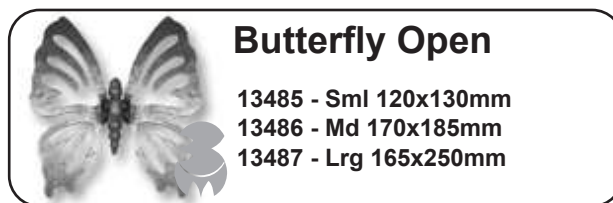

**Butterfly Open**

13485 - Sml 120x130mm  
13486 - Md 170x185mm  
13487 - Lrg 165x250mm

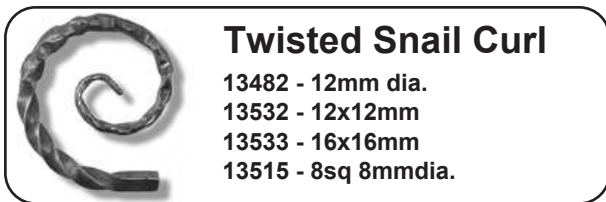

**Twisted Snail Curl**

13482 - 12mm dia.  
13532 - 12x12mm  
13533 - 16x16mm  
13515 - 8sq 8mmdia.

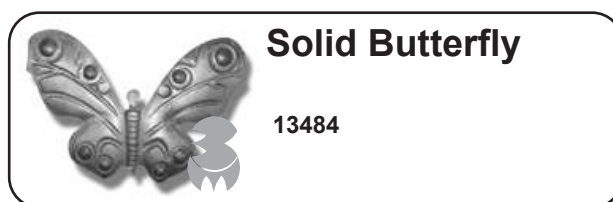

**Solid Butterfly**

13484



**13510**

Arum Candle  
Holder on Stem



**13527**

Lion Foot  
100 x 55mm



**13445**

Scorpion Tail

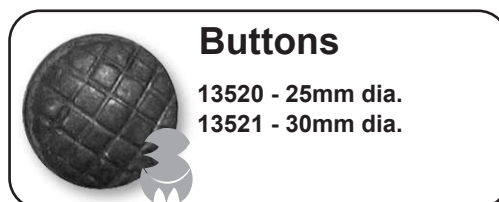

**Buttons**

13520 - 25mm dia.  
13521 - 30mm dia.

# Steel Pressings Forgings & Hammerings: Group 1 - Pressings & Forgings

11751



Weather Cock Set with Letters & Swivel  
485 x 410mm

11752



Weather Eagle Set with Letters & Swivel  
690 x 500mm

11753



Weather Guinea Fowl Set with Letters & Swivel  
440 x 300mm

Fish Eagle



11763 - Large 400 x 500mm  
11764 - Small 300 x 400mm  
11765 - 3D (double) on arrow 400 x 500mm

# Steel Pressings Forgings & Hammerings: Group 1 - Pressings & Forgings

11766



Rooster Silhouette  
400 x 300mm

11767



Zebra Head Silhouette  
400 x 300mm

Rhino Silhouette



11770 - Small 400 x 260mm  
11771 - Large 605 x 360mm

Elephant Head Front



11768 - Large 620 x 480mm  
11769 - Small 470 x 360mm

# Steel Pressings Forgings & Hammerings: Group 1 - Pressings & Forgings

**13462**



Single Curtain Rod Fit  
25mm dia.  
Bracket 115 x 95mm

**13463**



Double Curtain  
Rod Bracket  
Fit 25 mm dia.

**13438**



Spoon Spike  
12sq x 150mm

**Monkey Feet**



13406 - Small 30x55mm  
13407 - Medium 60x55mm  
13408 - Large 45x67mm



**Patterned wallplate**

13451 - 30 x 6 x 100mm  
13452 - 40 x 100 x 6mm  
13453 - 50 x 159 x 6mm

**13436**



Spoon Spike W Ball  
16sq x 150mm

**Tassels**



13412 - Small 12x55mm  
13413 - Medium 16x72mm  
13414 - Large 25x95mm



**Patterned Wallplate**

13450 - 230 x 120 x 3mm  
13450T - 230 x 120 x 5mm

**Bath Foot**



13951 - W100 x D110 x H165mm  
13952 - W140 x D110 x H185mm  
13953 - W215 x D175 x H160mm

# Steel Pressings Forgings & Hammerings:

## Group 1 - Handles & centre pieces



### Diamond Insert

13476 - 12sq 220 x 85 mm  
13477 - 16sq 230 x 95mm  
13478 - 20sq 240 x 105mm



### Twisted Handle

13410 - 140 x 70mm



### Door Handle Plate

13447 - 300mm  
13508 - 200mm



### Centre pieces

13464S - 16x150mm square  
13464R - 16x150mm round  
13464H - 16x150mm hexagonal

13467S - 20x150mm square  
13467R - 20x150mm round  
13467H - 20x150mm hexagonal

13468S - 25x150mm square  
13468R - 25x150mm round  
13468H - 25x150mm hexagonal

13469S - 30x150mm square  
13469R - 30x150mm round  
13469H - 30x150mm hexagonal

13465S - 40x150mm square  
13465R - 40x150mm round  
13465H - 40x150mm hexagonal



### Centre pieces

13470S - 16x150mm square  
13470R - 16x150mm round  
13470H - 16x150mm hexagonal

13473S - 20x150mm square  
13473R - 20x150mm round  
13473H - 20x150mm hexagonal

13474S - 25x150mm square  
13474R - 25x150mm round  
13474H - 25x150mm hexagonal

13472S - 30x150mm square  
13472R - 30x150mm round  
13472H - 30x150mm hexagonal

13471S - 40x150mm square  
13471R - 40x150mm round  
13471H - 40x150mm hexagonal

# Steel Pressings Forgings & Hammerings: Group 1 - Balls & Rings



## Cast Ball

13920 - 25mm dia  
13921 - 30mm dia  
13922 - 40mm dia  
13923 - 50mm dia  
13926 - 80mm dia  
13927 - 90mm dia  
13928 - 100mm dia  
13930 - 120mm dia



## 2 Ring Base

13418 - 30mm  
13455 - 20mm



## 3 Ring Base

13417 - 30mm  
13456 - 20mm

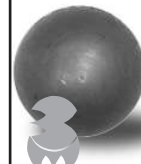

## Spun Hollow Ball Welded

13961 - 50mm dia.  
13962 - 76mm dia.  
13963 - 100mm dia.  
13964 - 120mm dia.  
13965 - 150mm dia.



## Hemisphere

13931 - 30mm dia  
13932 - 55mm dia  
13933 - 75mm dia  
13934 - 90mm dia  
13935 - 100mm dia  
13936 - 22mm dia  
13937 - 38mm dia  
13941 - 140mm dia

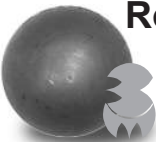

## Round Steel Ball

13911 - 15mm dia  
13912 - 20mm dia  
13913 - 25mm dia  
13914 - 30mm dia  
13915 - 40mm dia  
13916 - 50mm dia  
13917 - 60mm dia  
13918 - 70mm dia  
13919 - 80mm dia



## Turned Steel Ball

13902 - 16mm dia  
13903 - 20mm dia  
13904 - 25mm dia  
13905T - 30mm dia



## Round Bar Ring

15401 - 6mm dia x 60  
15402 - 6mm dia x 180  
15404 - 6mm dia x 40  
15405 - 6mm dia x 165



## Diamond Facet Steel Ball

13906 - 25mm dia  
13907 - 30mm dia  
13908 - 40mm dia  
13909 - 50mm dia

## Spun Hollow Ball



13942 - dia 50mm  
13943 - dia 63mm  
13944 - dia 76mm  
13945 - dia 100mm  
13946 - dia 130mm



## Round Bar Ring

15406 - 8mm dia x 70  
15407 - 8mm dia x 80  
15408 - 8mm dia x 100  
15414 - 8mm dia x 60  
15415 - 8mm dia x 90  
15419 - 8mm dia x 180

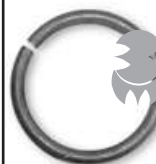

## Round Bar Ring

15421 - 8mm dia x 200  
15422 - 8mm dia x 230  
15427 - 10mm dia x110  
15424 - 10mm dia.x 80  
15426 - 10mm dia x 100  
15428 - 10mm dia x 120  
15429 - 10mm dia x 130  
15436 - 12mm dia x 100  
15438 - 12mm dia x 120  
15439 - 12mm dia x 130  
15440 - 12mm dia x 140



# Steel Pressings Forgings & Hammerings: Group 1 - Rings & Bars



**Square Bar Ring**

- 15454 - 8sq x 80mm
- 15455 - 8sq x 90mm
- 15456 - 8sq x 100mm
- 15466 - 10sq x 100mm
- 15467 - 10sq x 114mm
- 15468 - 10sq x 120mm
- 15469 - 10sq x 130mm
- 15470 - 10sq x 150mm



**Square Bar Ring**

- 15476 - 12sq x 100mm
- 15477 - 12sq x 110mm
- 15478 - 12sq x 120mm
- 15479 - 12sq x 130mm
- 15480 - 12sq x 140mm
- 15481 - 16sq x 130mm



**Square Twisted Ring**

- 15511 - 10sq x 60mm
- 15512 - 10sq x 100mm
- 15514 - 10sq x 120mm
- 15515 - 10sq x 130mm
- 15522 - 12sq x 100mm
- 15524 - 12sq x 120mm
- 15525 - 12sq x 130mm



**Twisted Ring**

- 15502 - 8x65mm
- 15503 - 8x75mm
- 15504 - 8x85mm
- 15506 - 8x100mm
- 15507 - 8x110mm
- 15510 - 8x180mm



**3/4 Ring**

- 15489 - 12sq x 135mm
- 15492 - 10sq x 100mm



**Flat Bar Ring**

- 15490 - 20x8x125mm Plain
- 15491 - 20x8x125mm Hammrdr



**Rnd Hammered Rod**

- 15607 - 6mm dia x 1M
- 15608 - 6mm dia x 2M
- 15609 - 6mm dia x 3M
- 15617 - 8mm dia x 1M
- 15618 - 8mm dia x 2M
- 15619 - 8mm dia x 3M
- 15627 - 10mm dia x 1M
- 15628 - 10mm dia x 2M
- 15629 - 10mm dia x 3M



**Rnd Hammered Rod**

- 15639 - 12mm dia x 3M
- 15649 - 16mm dia x 3M
- 15659 - 20mm dia x 3M
- 15662 - 25mm dia x 3M

# Steel Pressings Forgings & Hammerings: Group 1 - Bars



**Edge Hammered Tube**

Lengths up to 6m  
 15600 - 12sqmm x 2.0  
 15601 - 16sqmm x 2.0  
 15602 - 19sqmm x 2.0  
 15603 - 25sqmm x 2.0  
 15604 - 32sqmm x 2.0  
 15605 - 38sqmm x 2.0  
 15606 - 50sqmm x 2.0

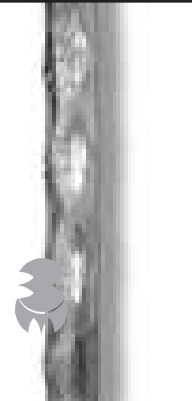

**Edge Hammered Bar**

Lengths up to 6m  
 15625 - 10sqmm x 1M  
 15634 - 12sqmm x 1M  
 15645 - 16sqmm x 2M  
 15655 - 20sqmm x 1M  
 15665 - 25sqmm x 1M



**Side Hammered Tube**

Lengths up to 6m  
 15670 - 50sqmm x 1.6  
 15671 - 16sqmm x 1.6  
 15672 - 20sqmm x 1.6  
 15673 - 25sqmm x 1.6  
 15674 - 38sqmm x 1.6  
 15675 - 32sqmm x 1.6

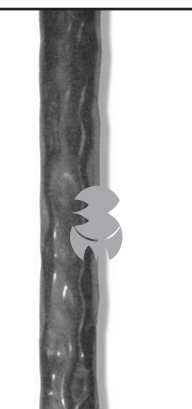

**Hammered Tube**

Lengths up to 6m  
 15676 - 32mm dia. x 1.6  
 15678 - 25mm dia. x 1.6  
 15680 - 38mm dia. x 1.6  
 15681 - 50mm dia. x 1.6  
 15696 - 20mm dia x 1.6



**Full Twisted Bar**

Lengths up to 6m  
 15700 - 8sqmm x 1M  
 15701 - 10sqmm x 1M  
 15712 - 12sqmm x 1M  
 15721 - 16sqmm x 1M  
 15731 - 20sqmm x 1M  
 15741 - 25sqmm x 1M

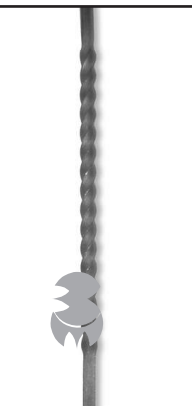

**Centre Twisted Bar**

15704 - 10sqmm x 1M  
 15714 - 12sqmm x 1M  
 15724 - 16sqmm x 1M  
 15734 - 20sqmm x 1M  
 15754 - 20 x 5mm x 1M

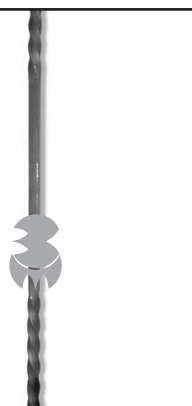

**Double/Reverse Twisted Bar**

15705 - 10sqmm x 1M  
 15717 - 12sqmm x 1M  
 15727 - 16sqmm x 1M  
 15737 - 20sqmm x 1M  
 15747 - 25sqmm x 1M

# Steel Pressings Forgings & Hammerings:

## Group 1 - Bars



**Twisted Tubing**

- 15794 - 19mm dia. 1.6 x 3M
- 15795 - 25mm dia. 1.6 x 3M
- 15796 - 32mm dia. 1.6 x 3M
- 15797 - 38mm dia. 1.6 x 3M
- 15798 - 50mm dia. 1.6 x 3M
- 15799 - 76mm dia. 1.6 x 3M



**15860**

Long Wave Bar  
6mm dia. x 2.7M



**Twisted Rod (Rope)**

- 15844 - 8sqmm x 1M 4st
- 15847 - 8sq mm x 1M 4st
- 15848 - 8sq mm x 2M 4st
- 15849 - 8sq mm x 3M 3st
- 15854 - 10sq mm x 1M 3st
- 15855 - 10sq mm x 2M 3st
- 15856 - 10sq mm x 3M 3st
- 15857 - 10sq mm x 1M 4st
- 15858 - 10sq mm x 2M 4st
- 15859 - 10sq mm x 3M 4st



**Fluted Bar**

- 15718 - 12sq mm x 1M (Full Twist)
- 15719 - 12sq mm x 1M (Centre Twist)
- 15720 - 12sq x 1M (Double Twist)



**Twisted Rod (Rope)**

- 15833 - 6mm x 3M 2st
- 15834 - 6sqmm x 1M 3st
- 15835 - 6sqmm x 2M 3st
- 15836 - 6sqmm x 3M 3st
- 15837 - 6sqmm x 1M 4st
- 15838 - 6sqmm x 2M 4st
- 15839 - 6sqmm x 3M 4st



**2 End Tapered Tube**

- 16521 - 25mm dia. x 900mm
- 16525 - 32mm dia. x 900mm



**Resin Balustrade Ball**

- 16522 - 75mm OD x 25mm
- 16526 - 100mm OD x 32mm



**Spline Tube**

- 15786 - 25 dia. x 1.2m
- 15789 - 50 x 1.6mm x 5.6m
- 15790 - 70 x 1.6mm x 5.9m